

# DIN B - Serie TBB[...]-AD

## terminal block

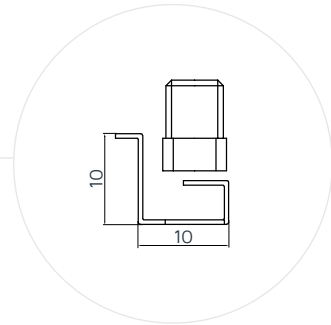
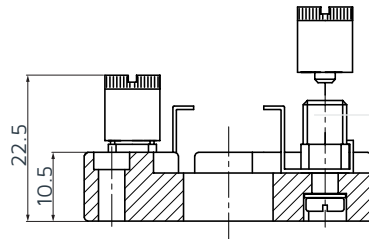

### MATERIAL OF BASE

Steatite

### FIXING DISTANCE

33 mm

### MATERIAL OF TERMINALS

Nickel-plated brass

Example of ordering code: **TBB500-AD2**

### MOUNTING BY DISC

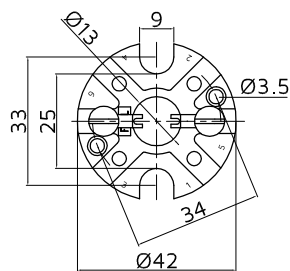

TBB500-AD

### MOUNTING BY SCREWS

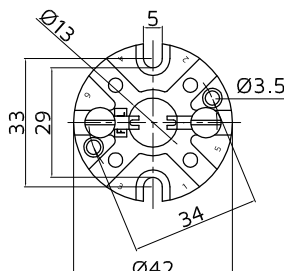

TBB600-AD

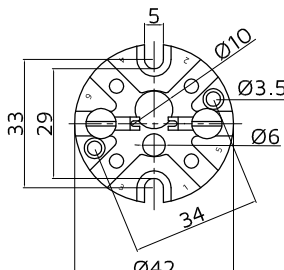

TBB670-AD

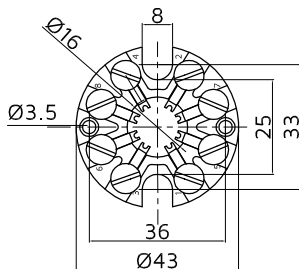

TBB850-AD

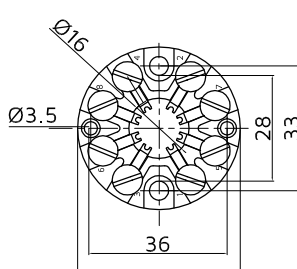

TBB800-AD

a	b				
CODE	PINS NUMBER				
	2	3	4	6	8
TBB500-AD					
TBB501-AD					
TBB502-AD					
TBB503-AD					
TBB600-AD					
TBB601-AD					
TBB602-AD					
TBB603-AD					
TBB670-AD					
TBB671-AD					
TBB672-AD					
TBB673-AD					
TBB800-AD					
TBB850-AD					